

SMA ATTENUATOR
22 DB 15 GHZ 2W

R411.822.000
Series : ATTENUATOR

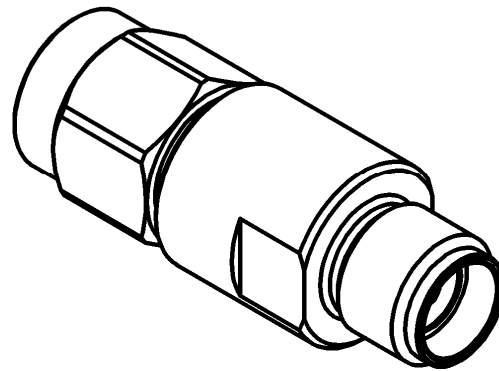

All dimensions are in mm.

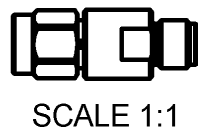
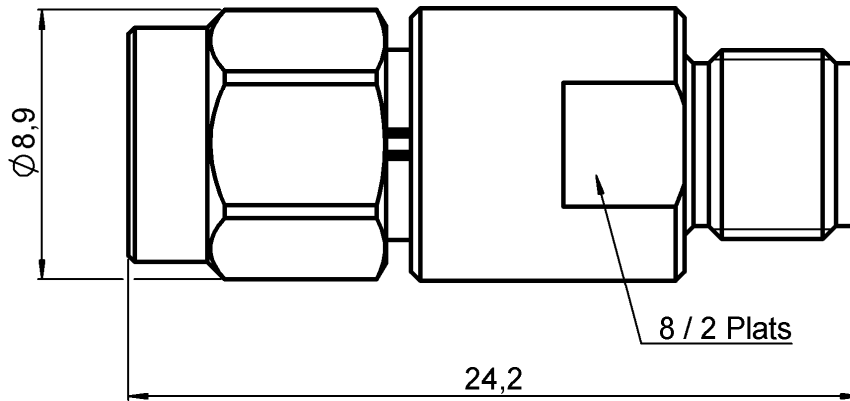

COMPONENTS	MATERIALS	PLATING(μm)
BODY	STAINLESS STEEL	PASSIVATION
MALE CENTER CONTACT	BERYLLIUM COPPER	GOLD 2.5 OVER NICKEL 1
FEMALE CENTER CONTACT	BERYLLIUM COPPER	GOLD 2.5 OVER NICKEL 2
OUTER CONTACT		
INSULATOR	PTFE	
GASKET	SILICONE RUBBER	
SUBSTRATE	ALUMINA	
RESISTOR	THIN FILM	
OTHERS PARTS		

Issue : 0834 A

In the effort to improve our products, we reserve the right to make changes judged to be necessary.

SMA ATTENUATOR
22 DB 15 GHZ 2W

R411.822.000
Series : ATTENUATOR

ELECTRICAL CHARACTERISTICS

Frequency (GHz)	DC - 4	4 - 8	8 - 12.4	12.4 - 15
V.S.W.R (≤)	1.20	1.25	1.30	1.50
Deviation(±dB)	+0.6 / -0.6	+0.7 / -0.6	+1.0 / -0.6	+1.4 / -0.6

Operating Frequency Range	DC - 15	GHz
Impedance	50	Ω
Nominal Attenuation	22	dB
Peak power at 25°C (1μs, 1%)	100	W
Average power at 25°C	2	W (Free Air Cooled)
		W (Conduction Cooled)

MECHANICAL CHARACTERISTICS

Connectors	SMA	Male Female	MIL-C 39012
Weight	6,6430 g		

ENVIRONMENTAL CHARACTERISTICS

Operating temperature range	-55 /+125 °C
Storage temperature range	-55 /+125 °C



SPECIFICATION

OTHER CHARACTERISTICS

Issue : 0834 A

In the effort to improve our products, we reserve the right to make changes judged to be necessary.

